

Skytower

AF-TA Sky design - Winner of the red*dot* design award: Product Design „best of the best 2011“

The design version of the Skytower, the “**Sky design**”, has absolutely convinced 2011 the judges of the red dot design award, one of the most renowned international product competitions.

The jury of highly respected experts has now awarded this desk connector panel with the “**red dot: best of the best**”, a prize reserved strictly for top design quality only.

In the red dot award: product design 2011, the distinguished jury had 4,433 products to choose from when awarding this special prize.:

“The KOMTECH connector panel „**Sky design**“ is a perfect combination of exclusive design and excellent workmanship.

Because of the silver powdered surface, the special design of cover and frame and its chamfered edges, the “**Sky design**” created a very special, modern and charismatic touch in conference rooms. The interior, noble rounded with a black plexiglass plate, is individual mountable. A sophisticated magnetic catch allows an easy access to the power and data connectors from all four sides.

Equipped with a media control, which offers a variety of functions the “**Sky design**” could be adapted customized.

Blue lighted keys are integrated spacesaving.

This enables the user a quickly access to the control functions even in dark rooms.”

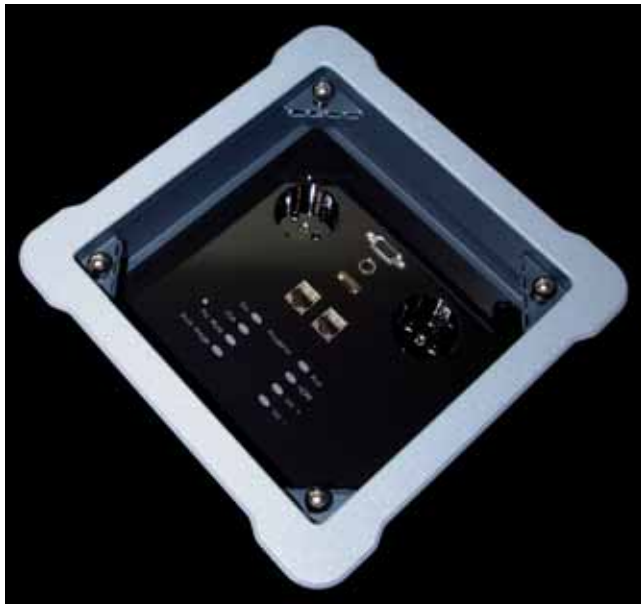
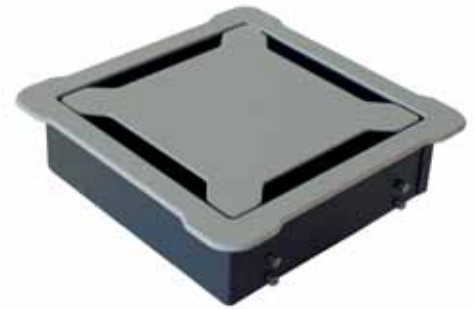

reddot design award
best of the best 2011

Type	Item No.
AF-TA Sky design	on request

Desk connector panel AF-TA Skytower

The Skytower is a perfect combination of superior design and excellent quality of manufacturing. Elegant embedded in the table he enabled about a cleverly devised magnetic lock the four side open access to the electrical and data supply. 2x8TE for individuell additions out of the modular connector panel program be available about the modular expandability. All cables disappears in the base so that they can mounted invisible at the floor pod.

Product characteristic

- attractive design
- excellent quality of manufacturing
- four side access
- invisible connector panel, even with plugged cables
- customized mounting
- modular expandability
- variable adjustable on different sizes (60-80cm) via tower and base
- also available with integrated PI/O-control

Two adapted patch cable VGA, Audio & LAN-Kombicable (1m) are included in delivery. The bus bar and power supply is fixed conducted about a cable to the floor.



Interior view connector



Interior view PI/O

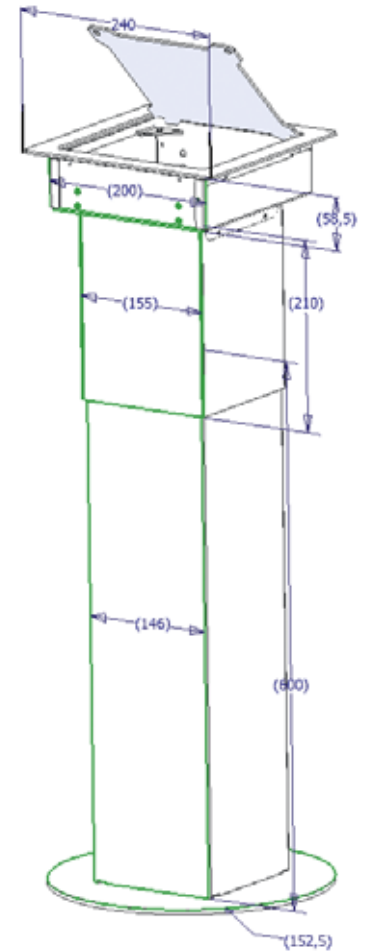

Detail drawing: Skytower with option tower and base

AF-TA Hybrid Skytower

for customized connector field mounting, without tower and base

Type	Item No.
AF- TA Hybrid Skytower	06006664
Option Skytower illumination	06006666
Option tower and base	

AF-TA Skytower

with 2x Schuko-power socket based on DIN VDE-Norm *1)

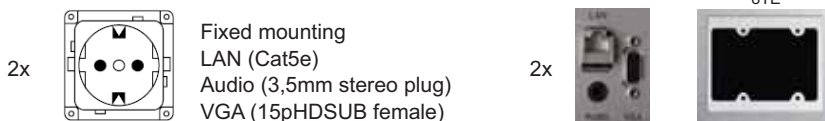

Type	Item No.
AF- TA Skytower	06006720

AF-TA Skytower UTE

with 2x Schuko-power socket based on NF-Norm *2)

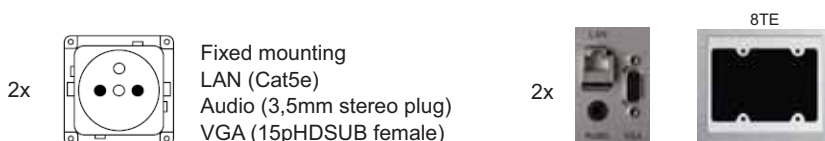

Type	Item No.
AF- TA Skytower	0600***

AF-TA Skytower CH

with 2x Schuko-power supply based on SEV-Norm *₃)

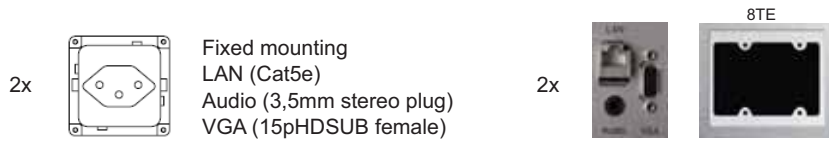

Type	Item No.
AF- TA Skytower CH	0600***

AF-TA Skytower USA

with 2x Schuko-power supply based on USA-Norm *₄)

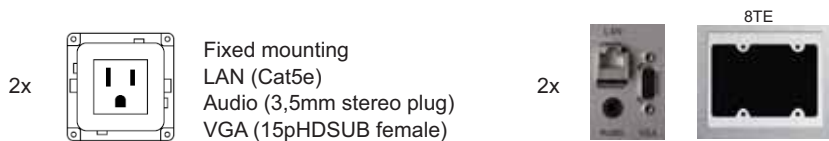

Type	Item No.
AF- TA Skytower USA	0600***

AF-TA Skytower UK

with 2x Schuko-power supply based on UK-Norm *₅)

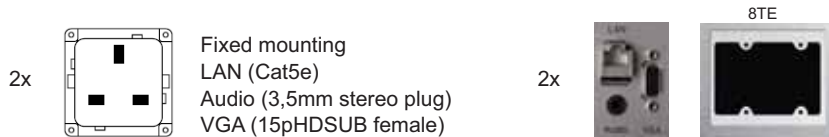

Type	Item No.
AF- TA Skytower UK	0600***

AF-TA Skytower PI/O-08

with 2x Schuko-power supply based on DIN VDI-Norm *₁)

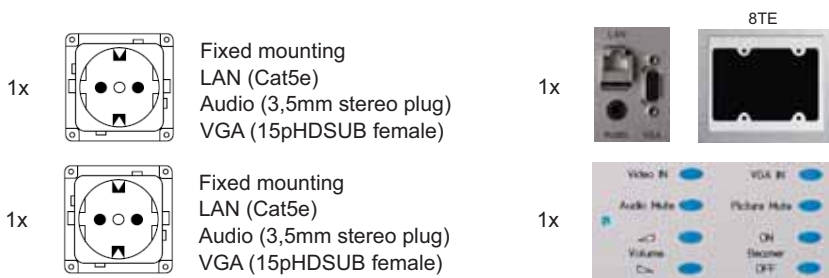

Type	Item No.
AF- TA Skytower PI/O	0600***

The standard of power socket color is black, the standard of surface of frames, covers and connector plates Alu rolled. Other colors and types on request.

*1) applicable in: Afghanistan, Andorra, Bulgaria, Chile, Germany, Estonia, Finland, Indonesia, Iceland, (partially) Italy, Netherlands, Norway, Austria, Portugal, Romania, San Marino, Sweden, Slovenia, Spain, South Korea, Hungary, Vatican
 *2) applicable in: Belgium, France, Monaco, Poland, Slovakia, Czech Republic
 *3) applicable in: Liechtenstein, Switzerland
 *4) applicable in: Canada, Mexico, South America (partially), USA
 *5) applicable in: Dubai, Great Britain, Hong Kong, Ireland, Malaysia, Malta, Singapore, Cyprus

Suitable Modules

Audio / Video

BNC feed through

4TE-Modul with feed through connector

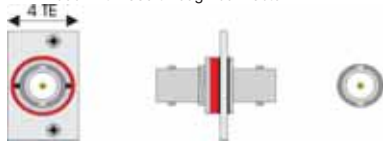

Type	Item No.
BNC female/female	06006006
BNC female/female, identification ring green	06006007
BNC female/female, identification ring blue	06006008
BNC female/female, identification ring black	06006009
BNC female/female, identification ring white	06006010
BNC female/female, identification ring yellow	06006011

BNC with 1m cable

4TE-Modul with BNC female convert on BNC male



Type	Item No.
BNC-female/BNC-male 1m, identification ring red	06006313
BNC-female/BNC-male 1m, identification ring green	06006316
BNC-female/BNC-male 1m, identification ring blue	06006319
BNC-female/BNC-male 1m, identification ring black	06006257
BNC-female/BNC-male 1m, identification ring white	06006323
BNC-female/BNC-male 1m, identification ring yellow	06006177

BNC & 2x RCA feed through

4TE-Modul mit feed through connector

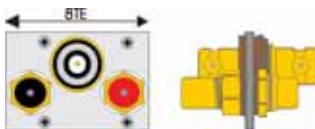

Type	Item No.
BNC-female/female & 2xRCA	06006440

RCA feed through

4TE-Modul with feed through connector

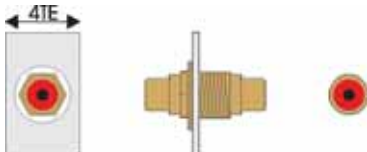

Type	Item No.
RCA-female/female, Identification ring red	06006432
RCA-female/female, Identification ring black	06006433
RCA-female/female, Identification ring yellow	06006434

RCA with 1 m cable

4 TE-Modul with RCA female convert on RCA male



Type	Item No.
RCA-female/RCA-male 1m, Identification ring red	06006175
RCA-female/RCA-male 1m, Identification ring black	06006176
RCA-female/RCA-male 1m, Identification ring yellow	06006781

RCA feed through 3x **New**

4 TE-Modul with feed through connector

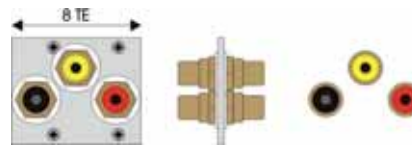

Type	Item No.
3xRCA female/female	06006438

S-Video feed through (4pin Mini-DIN)

4 TE-Modul with feed through connector

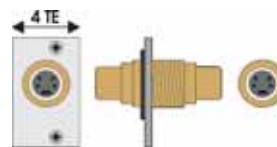

Type	Item No.
S-Video female/female	06006343

S-Video & Audio RCA feed through

8TE-Modul with feed through connector

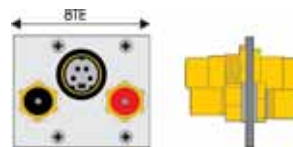

Type	Item No.
S-Video & 2xRCA female/female	06006439

3,5mm stereo plug feed through

4TE-Modul with feed through connector

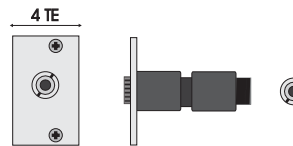

Type	Item No.
3pin mini plug female/female	06006435

XLR 3pin

8TE-Modul mit XLR-female 3pin solderable

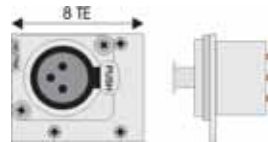

Type	Item No.
XLR-female-3p solderable	06006025

XLR 5pin

8TE-Modul mit XLR-Buchse 5pin solderable

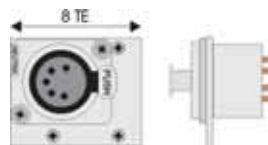

Type	Item No.
XLR-female-5p solderable	06006065

Suitable Moduls

VGA

15pin HDSUB feed through

8TE-Modul with 15pin HDSUB female convert on female



8 TE-Modul with 15pin HDSUB male convert on male



Type	Item No.
VGA-female	06006049
VGA-male	06006050

DVI

DVI feed through *New*

8TE-Modul with feed through connector

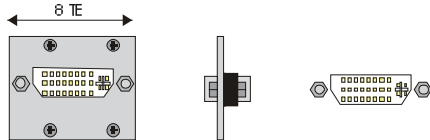

Type	Item No.
DVI-I-female	06006431

RS232

9pin DSub feed through

8TE-Modul with 9pin DSub female convert on female

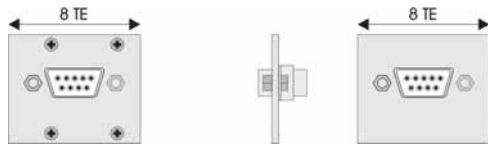

8 TE-Modul with 9pin DSub male convert on male



8 TE-Modul with 9pin DSub female convert on male



8 TE-Modul with 9pin DSub male convert on male



Type	Item No.
9pin D-Sub female/female	06006043
9pin D-Sub male/male	06006044
9pin D-Sub female/male	06006167
9pin D-Sub male/female	06006185

HDMI

HDMI feed through *New*

8TE-Modul with feed through connector

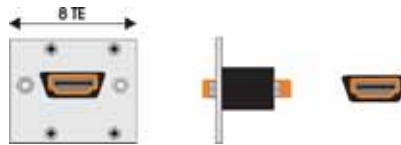

Type	Item No.
HDMI-female	06006430

USB

USB-A feed through

4TE-Modul with feed through connector



Type	Item No.
USB-A-female	06006175

USB-B feed through *New*

4TE-Modul with feed through connector

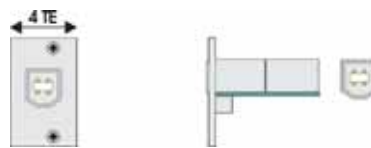

Type	Item No.
USB-B-female	on request

Firewire

FW400 feed through 6pol Fire-Wire female/female

4TE-Modul with feed through connector



Type	Item No.
FW-female	06006412

Push-button

Push-button high-grade steel solderable



Push-button high-grade steel with LED, solderable *New*



Type	Item No.
Push-button high-grade steel	06006677
Push-button high-grade steel LED green	06006698

KOMTECH Kommunikationstechnik GmbH
Straßheimer Str. 45
61169 Friedberg / Hessen
Germany
Fon +49 (0) 60 31 / 79 47 - 0
Fax +49 (0) 60 31 / 79 47 - 47
info@komtech.de
www.komtech.de
