

A close-up photograph of a white desk connector panel. The panel is partially open, revealing a dark interior with a brush-like seal. Below the panel, a control interface is visible, including a power switch, a VGA port, and a power outlet. The background is a light, neutral color.

Connector Panels

*Image: By courtesy of Interstuhl Büromöbel GmbH & Co. KG
Unauthorized use is not allowed.*

On the following pages you receive an insight about the multifaced design and application possibilities of our connector panels.

- **Noble standard or design profile**
- **Discreetly integrated in the table or above**
- **Simple media control or all-round talent**

KOMTECH desk connector panels always promise you a noble design in your meeting rooms and will convince you with their high-quality processing and individual design.

Extensive possibilities of application and function combined with a multifaced choice of surface designs leaves hardly nothing to be desired.

Overview Desk Connector Panels

Connector Panel Standard

- AF-TA Standard 24TE
- AF-TA Standard 40TE
- AF-TA Standard 48TE

- AF- desk box

Connector Panel Hybrid

- AF-TA Hybrid T-300
- AF-TA Hybrid T-380
- AF-TA Hybrid T-520

- AF-TA Hybrid SE 160

Connector Panel Hybrid Slim

- AF-TA Hybrid Slim T-315
- AF-TA Hybrid Slim T-365

Connector Panel Skytower

- AF-TA Skytower with tower
- AF-TA Skytower without tower
- AF-TA Skytower with PI/O control system

- AF-TA Sky KCC S6

Connector Panel Design Profil

- AF-TA DP-125
- AF-TA DP-230
- AF-TA DP-380

Connector Panel fold-out

- AF-TA Dubai
- AF-TA Conference
(with fold-out Revoluto Microphone)

Under Table Connector Panel

- AF-UTA 230V

Mobile Connector Panel

- AF-TA Net Tower

Modular Connector Panels

- Connector panels and modules for switch frames
- Connector panels for floor pods

- VGA Interface floor pod
- Equipment for floor pods
- Connector panels for cable channels

Modular Connector Panels

- KOMTECH Connector panel modules
- Keystone module system
- Ecoflex Modules

WinPlan2

Module planning software

for Windows XP / Vista

The module planning software WinPlan2 offers you the possibility to design and create connector panels and free definable connector plates on your own PC.

Assamble free connector plates with elements, TE module bearings, borings and engravings. Choose your optional RAL color surface.

You can print, import and export your project datas.

A mounting list and list of items view will help you to choose the right modules for your personalized desk connector panel or switch frame.

The list of items view is optional available with price calculation. So you can directly see, what's the price of your product.

Your project items can be saved as *.bmp or *.jpg files for further use.

The order will be processed via the integrated email dispatch.

Futher WinPlan2 has a filter and search function, an automatic software update and is multilingual (German, English,...) available.

You can find **WinPlan2** on our homepage www.komtech.de / „Connector Panels“.
Please click „Download from Komtech-Server“ and follow the instructions!

You have problems??? - Give us a call! Our sales associates are gladly to help you!

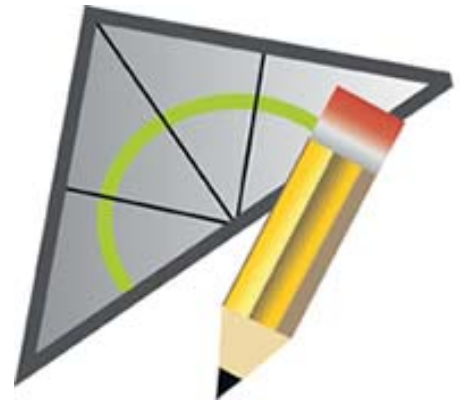

Important information for Windows Vista user:

KOMTECH **WinPlan2** has to be executed as administrator at Microsoft Windows Vista / Microsoft Windows 7.

Please follow step by step:

- Install program
- Right klick on file "**WP2.exe**" in the installation path
- Left klick on "**Characteristics**"
- Klick "**Compatibility**"
- Check mark at "**Execute program as administrator**"
- "**Transfer**" and "**OK**" - **Finish!**

AF-TA Standard

The beginning ► The KOMTECH AF-TA Standard Series.

Standardly equipped with the surface Aluminium HQ Structure with Superb Resistance Eloxal, two Schuko power sockets and 2m power cable, these connector panels provides a lot of room for cables and/or power supplies. There is no tangle of cables on the table.

Options:

A noble range of surface designs, like aluminium rolled, steel anthracite or high quality steel, for example, are at your disposal.

Would you like to have coloured panels?- No problem!
We graded up your desk connector panel in every RAL colour.
Optional a customized mounting and labeling of the connector panel is available.



Example:
high quality steel surface

AF-TA Standard 24TE

with two Schuko power sockets and 2m power cable



TA Standard 24TE,
grey powdered
customized mounted

Dimensions:

- W x D 300mm x 200mm
- Installation depth 108mm
- Installation cut out 280mm x 180mm

Type	Item No.
AF-TA 24TE aluminium HQ Structure	06006750
AF-TA mounting & labeling flat rate 24TE	06006552
AF-TA boring template 24TE	06006667

AF-TA Standard 40TE

with two Schuko power sockets and 2m power cable

The desk connector panels 40TE could be expanded optional by mounting frames for 1/2 19" units, e. g. the mini series.
(Available for item no. 06006591,06006651 and 06006567)



TA Standard 40TE,
liquid coated black,
customized mounted

Dimensions:

- W x D 380mm x 200mm
- Installation depth 108mm

Type	Item No.
AF-TA 40TE aluminium HQ Structure	06006591
AF-TA mounting & labeling flat rate 40TE	06006557
AF-TA boring template 40TE	06006668
AF-TA mounting frame mini series	06006690
AF-TA mounting frame mini series extension	06006691

AF-TA Standard 48TE

with four Schuko power sockets and 2m power cable



TA Standard 48TE,
Alu HQ Structure
customized mounted

Dimensions:

- W x D 520mm x 200mm
- Installation depth 111mm

Type	Item No.
AF-TA 48TE aluminium HQ Structure	06006752
AF-TA mounting & labeling flat rate 48TE	06006558
AF-TA boring template 48TE	06006669

Further Options

Type	Item No.
AF-TA Option liquid coating basic price	06006641
AF-TA Option liquid coating unit price (per frame & cover)	06006642
AF-TA Option powder coating basic price	06006643
AF-TA Option powder coating unit price (per frame & cover)	06006644
Option power socket black Type E - France (per piece)	06006730
Option power socket black Type J - CH (per piece)	06006731
Option power socket black Type G - GB (per piece)	06006732
Option power socket black Type B - USA (per piece)	06006733

Desk Connector Panel TA-Hybrid

with 2m power cable

Corpus

The desk connector panels Hybrid are available in three sizes:

- T-300
- T-380
- T-520



These desk connector panels are customized or modular mountable.

About a one sided up to three sided strip the cable be conducted by closed cover out of the aluminium corpus.

An integrated, in closed status not visible delivery for lap top power supplies and connector cables provides order.

The cable connectors are optionally available solderable, pluggable or with customized cables.

Also available in function and application are multifaced possibilities, e.g. the mounting of external modules or a PI/O control technology.

Wire-eyelets for strain relief, high security by closed cover and physical separation between signal lines and power lines are well-ried integrated standards.

Aluminium HQ Structure with Superb Resistance Eloxal is our standard surface for cover and frame.

Dimensions

	W x H	mounting cut-out	mounting depth
T-300	300mm x 200mm	280mm x 180mm	108mm
T-380	380mm x 200mm	360mm x 180mm	108mm
T-520	520mm x 200mm	500mm x 180mm	108mm

Cover & Frame

Cover and Frame are available in following versions:

- One or three sided strip
- Aluminium rolled
- High-grade steel
- Corian®
- TIN surface
- Smoked glass
- Prepared for veneer
- Choose your own surface from about 500 different "Decor" surface designs!



Design example
"Decor"

Options

Further optional possibilities:

- Configuration of AF-TA Hybrid T-380 with a fold-out carrier for a **Revoluto** microphone of **beyerdynamic**)))
- Circular chamfered or outside rounded edges (see below)
- Expandable for 1/2 19" units (e. g. via troughs of the mini series)
- Individual gravures, like your company logo (template), e.g.

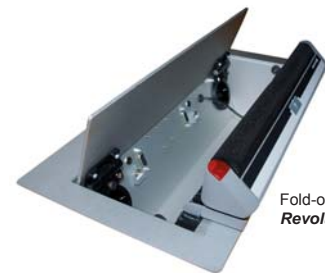

Fold-out
Revoluto microphone

Possible chamfer designs when basic material is aluminium

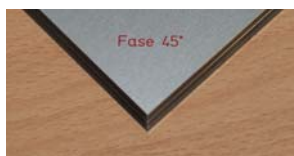

45° chamfer



45° chamfer with radius R5



external radius 2mm



external radius 2mm with radius R5

Connector Panels

Type	Item No.
AF-TA Hybrid T300 Basic HQ-Structure (incl. cover & frame)	06006756
AF-TA Hybrid T380 Basic HQ-Structure (incl. cover & frame)	06006757
AF-TA Hybrid T520 Basic HQ-Structure (incl. cover & frame)	06006758

Optional

Type	Item No.
AF-TA Option liquid coating basic price	06006641
AF-TA Option liquid coating unit price (per cover & frame)	06006642
AF-TA Option powder coating basic price	06006643
AF-TA Option powder coating unit price (per cover & frame)	06006644
AF-TA Boring template 24TE	06006667
AF-TA Boring template 40TE	06006668
AF-TA Boring template 48TE	06006669
AF-TA Customized gravure	06006645
AF-TA Option customer logo	06006653
AF-TA Option chamfer 45°/pointed	06006654
AF-TA Option chamfer, 45°/Radius R5	06006657
AF-TA Option outer radius R2/pointed	06006658
AF-TA Option outer radius R2/radius R5	06006659
Option power socket, black Type E - France (per piece)	06006730
Option power socket, black Type J - CH (per piece)	06006731
Option power socket, black Type G - GB (per piece)	06006732
Option power socket, black Type B - USA (per piece)	06006733

Option Microphone mounting for MPR Revoluto (beyerdynamic)))

(Only for T-380)

Type	Item No.
AF-TA Option MPR Revoluto mounting	06006755

This product can be
 individual customized
 with *WinPlan2* !!!
 Your personal price!
 Automatic generated!

Desk connector panel TA-Hybrid Slim T-315

Desk connector panel TA-Hybrid Slim T-365

Desk connector panel with lower installation depth
incl. 2m power cable

The room under the desk top to the floor is too small to integrate a connector panel in the desk?
Or should the connector panel be so unobtrusive as possible?
However your project requirements look - if the room is small, TA-Hybrid-Slim T-315 or T-365 are the answer.

Because of the extreme slim design the connector panels keep a low profile and maximized so the legroom of the user. Even an installation in folding tables is realizable. A secure mounting, design and connector possibilities like „a big one“ are further strong facts.



The noble surface aluminium HQ Structure with Superb Resistance Eloxal is our standard versions. On request the TA-Hybrid Slim-T315 and T-365 are also available in the version aluminium rolled, high grade steel, titan look or glass.

Product facts

- Low installation depth
- Compact construction
- Customizing possible
- Modular amplification possibilities



side view Hybrid Slim T-315

Dimensions T-315:

- W x D 315mm x 215mm
- Installation depth: 63mm
- Installation cutout: 295mm x 195mm
- **Attention:**
→ Optimized for table plates up to 30mm!

Dimensions T-365:

- W x D 365mm x 215mm
- Installation depth: 63mm
- Installation cutout: 345mm x 195mm
- **Attention:**
→ Optimized for table plates up to 30mm!



Do you have any questions about configuration? Our sales team will be glad to help you!

Possible chamfer designs when basic material is aluminium



outside radius R2/radius R5

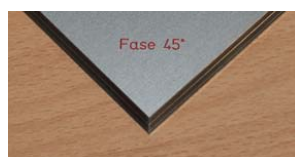

chamfer 45°/pointed



chamfer 45°/radius R5

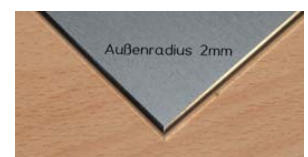

outside radius R2/pointed

This product can be individual customized with WinPlan2 !!!
Your personal price!
Automatic generated!

Type	Item No.
AF-TA Hybrid Slim T-315 Alu HQ Structure (incl. cover & frame)	06006753
AF-TA Hybrid Slim T-365 Alu HQ Structure (incl. cover & frame)	06006754
AF-TA option liquid coating basic price	06006641
AF-TA option liquid coating unit price (pro cover & frame)	06006642
AF-TA option powder coating basic price	06006643
AF-TA option powder coating unit price (pro cover & frame)	06006644
AF-TA boring template T-315	
AF-TA boring template T-365	
AF-TA customized engraving	06006645
AF-TA option customer logo	06006653
AF-TA option chamfer 45°/pointed	06006654
AF-TA option chamfer 45°/radius R5	06006657
AF-TA option outside radius R2/pointed	06006658
AF-TA option outside radius R2/radius R5	06006659
Option power socket black Type E - France (1 piece)	06006730
Option power socket black Type J - CH (1 piece)	06006731
Option power socket black Type G - GB (1 piece)	06006732
Option power socket black Type B - USA (1 piece)	06006733

AF-TA SE 160 and AF-TA Hybrid SE 160

The 1-working place-solution

- Compact design
- The complete unit is customized composed and mounted
- International power sockets available on request
- Standard design:
Surface: HQ Structure with Superb Resistance Eloxal
Outside radius 2mm with R5 (corner radius)
- Other surfaces on request



AF-TA SE 160 (Item No. 06006740)



Side fixing



Inside view:
AF-TA SE 160 with standard mounting (Item No. 06006740):

- 1x 230V Schuko power socket
- 1x RJ-45 Cat6 female, feethrough
- 1x VGA female, feethrough
- 1x 3,5mm stereo plug, feethrough

The connector panel SE 160 is available in two different versions:

- As already equipped connector panel with defined standards (Item No. 06006740)
- As Hybrid version, which will be tailored to your individual requirements (Item No. 06006665)

ATTENTION: If the connector panel has to be mounted flush to the table, please order/inquire explicit **WITHOUT outside radius!!!**

Technical Data

Dimensions (W x H x D) 160mm x 100mm x 61mm
 Operating temperature 15 - 45°C
 Weight (without modules) 0,5kg

Dimensions

Dimensions visible surface

Frame (W x D) 160mm x 100mm

Dimensions mounting cut-out

Cut-out (W x D) 150mm x 90mm

Connectors

depending on mounting

Standard mounting (Item No. 06006740)

1x 230V (Schuko)
 2x RJ45 (Catx)
 1x 15pin Sub-HD (VGA)
 1x 3,5mm stereo plug

Fastening

At table

Number of screws 4

Type	Item No.
AF-TA Hybrid SE 160 - ex connector plate	06006665
AF-TA Hybrid SE 160 - with standard mounting	06006740
Option power socket black Type E - France (per piece)	06006730
Option power socket black Type J - CH (per piece)	06006731
Option power socket black Type G - GB (per piece)	06006732
Option power socket black Type B - USA (per piece)	06006733

AF-TA Sky design - Winner of the red*dot* design award: Product Design „best of the best 2011“

The design version of the Skytower, the “**Sky design**”, has absolutely convinced 2011 the judges of the red dot design award, one of the most renowned international product competitions.

The jury of highly respected experts has now awarded this desk connector panel with the “**red dot: best of the best**”, a prize reserved strictly for top design quality only.

In the red dot award: product design 2011, the distinguished jury had 4,433 products to choose from when awarding this special prize.:

“The KOMTECH connector panel „**Sky design**“ is a perfect combination of exclusive design and excellent workmanship.

Because of the silver powdered surface, the special design of cover and frame and its chamfered edges, the “**Sky design**” created a very special, modern and charismatic touch in conference rooms. The interior, noble rounded with a black plexiglass plate, is individual mountable. A sophisticated magnetic catch allows an easy access to the power and data connectors from all four sides.

Equipped with a media control, which offers a variety of functions the “**Sky design**” could be adapted customized.

Blue lighted keys are integrated spacesaving.

This enables the user a quickly access to the control functions even in dark rooms.”

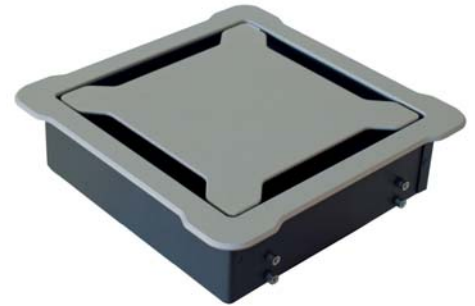

reddot design award
best of the best 2011

Type	Item No.
AF-TA Sky design	06006721

Desk connector panel AF-TA Skytower

The Skytower is a perfect combination of superior design and excellent quality of manufacturing. Elegant embedded in the table he enabled about a cleverly devised magnetic lock the four side open access to the electrical and data supply. 2x8TE for individuell additions out of the modular connector panel program be available about the modular expandability. All cables disappears in the base so that they can mounted invisible at the floor pod.

Product characteristic

- attractive design
- excellent quality of manufacturing
- four side access
- invisible connector panel, even with plugged cables
- customized mounting
- modular expandability
- variable adjustable on different sizes (60-80cm) via tower and base
- also available with integrated PI/O-control

Two adapted patch cable VGA, Audio & LAN-Kombicable (1m) are included in delivery. The bus bar and power supply is fixed conducted about a cable to the floor.



Interior view connector



Interior view PI/O

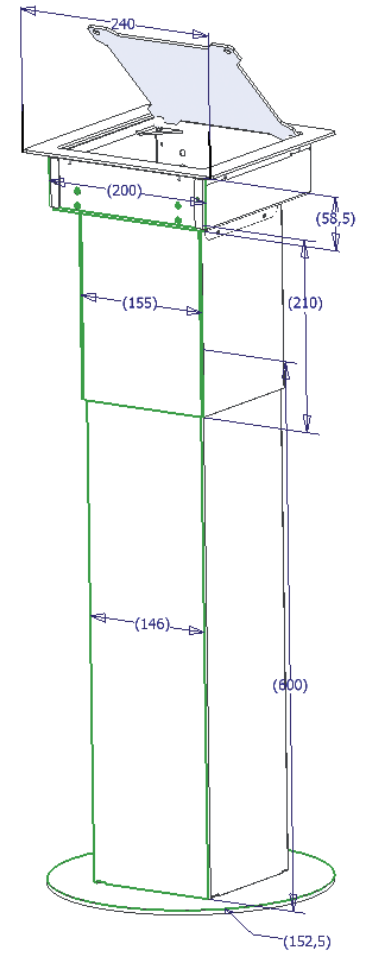

Detail drawing:
Skytower with option
tower and base

AF-TA Hybrid Skytower

for customized connector field mounting, without tower and base

Type	Item No.
AF- TA Hybrid Skytower	06006664
Option Skytower illumination	06006666
Option tower and base	

AF-TA Skytower

with 2x Schuko-power socket based on DIN VDE-Norm *1)

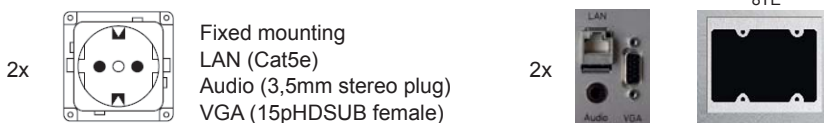

Type	Item No.
AF- TA Skytower	06006720

AF-TA Skytower UTE

with 2x Schuko-power socket based on NF-Norm *2)

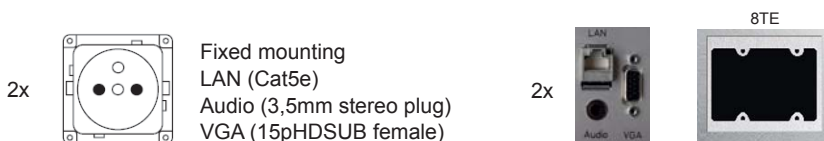

Type	Item No.
AF- TA Skytower	0600***

AF-TA Skytower CH

with 2x Schuko-power supply based on SEV-Norm *₃)

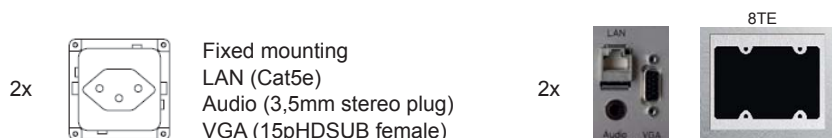

Type	Item No.
AF- TA Skytower CH	0600***

AF-TA Skytower USA

with 2x Schuko-power supply based on USA-Norm *₄)

15A/125V

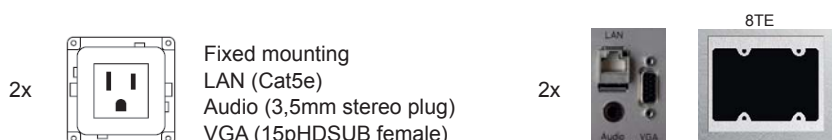

Type	Item No.
AF- TA Skytower USA	0600***

AF-TA Skytower UK

with 2x Schuko-power supply based on UK-Norm *₅)

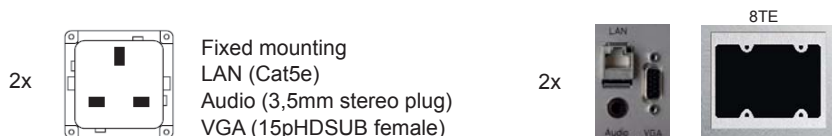

Type	Item No.
AF- TA Skytower UK	0600***

AF-TA Skytower PI/O-08

with 2x Schuko-power supply based on DIN VDI-Norm *₁)

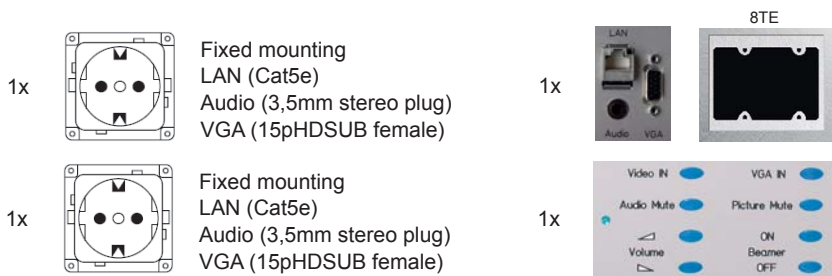

Type	Item No.
AF- TA Skytower PI/O	0600***

The standard of power socket color is black, the standard of surface of frames, covers and connector plates Alu rolled. Other colors and types on request.

*1) applicable in: Afghanistan, Andorra, Bulgaria, Chile, Germany, Estonia, Finland, Indonesia, Iceland, (partially) Italy, Netherlands, Norway, Austria, Portugal, Romania, San Marino, Sweden, Slovenia, Spain, South Korea, Hungary, Vatican
 *2) applicable in: Belgium, France, Monaco, Poland, Slovakia, Czech Republic
 *3) applicable in: Liechtenstein, Switzerland
 *4) applicable in: Canada, Mexico, South Amerika (partially), USA
 *5) applicable in: Dubai, Great Britain, Hong Kong, Ireland, Malaysia, Malta, Singapore, Cyprus

Suitable Modules

Audio / Video

BNC feed through

4TE-Modul with feed through connector

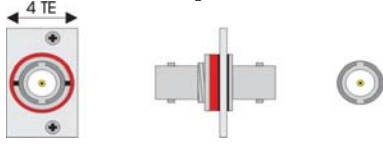

Type	Item No.
BNC female/female	06006006
BNC female/female, identification ring green	06006007
BNC female/female, identification ring blue	06006008
BNC female/female, identification ring black	06006009
BNC female/female, identification ring white	06006010
BNC female/female, identification ring yellow	06006011

BNC with 1m cable

4TE-Modul with BNC female convert on BNC male



Type	Item No.
BNC-female/BNC-male 1m, identification ring red	06006313
BNC-female/BNC-male 1m, identification ring green	06006316
BNC-female/BNC-male 1m, identification ring blue	06006319
BNC-female/BNC-male 1m, identification ring black	06006257
BNC-female/BNC-male 1m, identification ring white	06006323
BNC-female/BNC-male 1m, identification ring yellow	06006177

BNC & 2x RCA feed through

4TE-Modul mit feed through connector

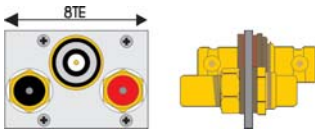

Type	Item No.
BNC-female/female & 2xRCA	06006440

RCA feed through

4TE-Modul with feed through connector

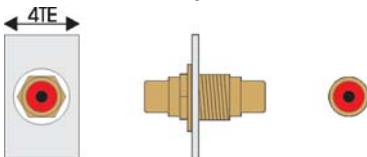

Type	Item No.
RCA-female/female, Identification ring red	06006432
RCA-female/female, Identification ring black	06006433
RCA-female/female, Identification ring yellow	06006434

RCA with 1 m cable

4 TE-Modul with RCA female convert on RCA male



Type	Item No.
RCA-female/RCA-male 1m, Identification ring red	06006175
RCA-female/RCA-male 1m, Identification ring black	06006176
RCA-female/RCA-male 1m, Identification ring yellow	06006781

RCA feed through 3x *New*

4 TE-Modul with feed through connector

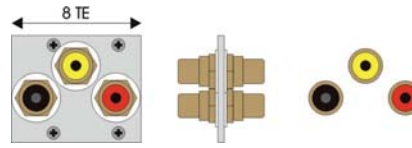

Type	Item No.
3xRCA female/female	06006438

S-Video feed through (4pin Mini-DIN)

4 TE-Modul with feed through connector

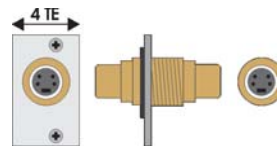

Type	Item No.
S-Video female/female	06006343

S-Video & Audio RCA feed through

8TE-Modul with feed through connector

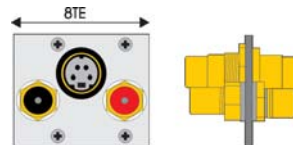

Type	Item No.
S-Video & 2xRCA female/female	06006439

3,5mm stereo plug feed through

4TE-Modul with feed through connector

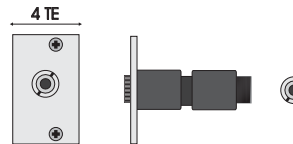

Type	Item No.
3pin mini plug female/female	06006435

XLR 3pin

8TE-Modul mit XLR-female 3pin solderable

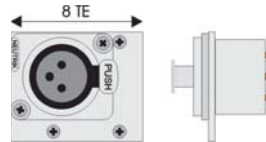

Type	Item No.
XLR-female-3p solderable	06006025

XLR 5pin

8TE-Modul mit XLR-Buchse 5pin solderable

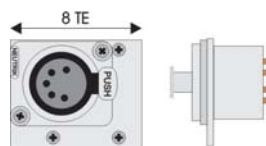

Type	Item No.
XLR-female-5p solderable	06006065

Suitable Moduls

VGA

15pin HDSUB feed through

8TE-Modul with 15pin HDSUB female convert on female

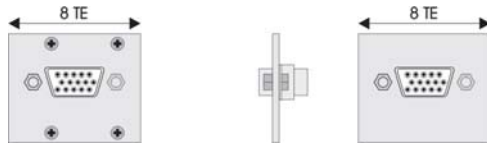

8 TE-Modul with 15pin HDSUB male convert on male

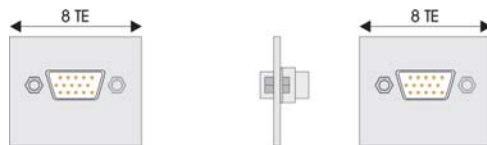

Type	Item No.
VGA-female	06006049
VGA-male	06006050

DVI

DVI feed through *New*

8TE-Modul with feed through connector

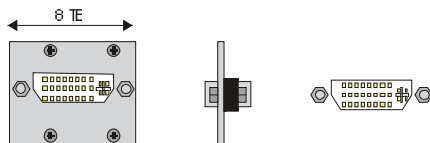

Type	Item No.
DVI-I-female	06006431

RS232

9pin DSub feed through

8TE-Modul with 9pin DSub female convert on female

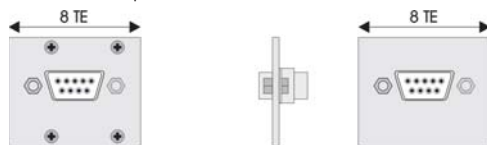

8 TE-Modul with 9pin DSub male convert on male



8 TE-Modul with 9pin DSub female convert on male

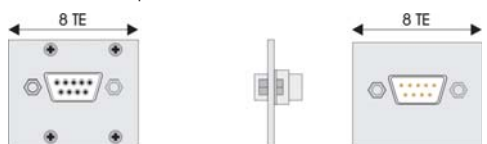

8 TE-Modul with 9pin DSub male convert on male

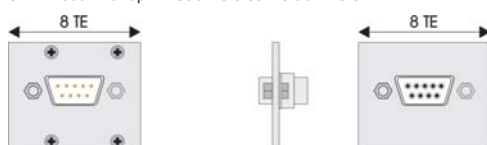

Type	Item No.
9pin D-Sub female/female	06006043
9pin D-Sub male/male	06006044
9pin D-Sub female/male	06006167
9pin D-Sub male/female	06006185

HDMI

HDMI feed through *New*

8TE-Modul with feed through connector

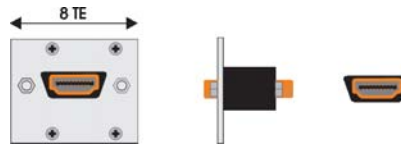

Type	Item No.
HDMI-female	06006430

USB

USB-A feed through

4TE-Modul with feed through connector



Type	Item No.
USB-A-female	06006175

USB-B feed through *New*

4TE-Modul with feed through connector



Type	Item No.
USB-B-female	on request

Firewire

FW400 feed through 6pol Fire-Wire female/female

4TE-Modul with feed through connector



Type	Item No.
FW-female	06006412

Push-button

Push-button high-grade steel solderable



Push-button high-grade steel with LED, solderable *New*



Type	Item No.
Push-button high-grade steel	06006677
Push-button high-grade steel LED green	06006698

AF-TA Sky KCC-S6

Little brother of TA Skytower

High-class mounting and individual design are identifying features of KOMTECH. Features which you can find also at this desk connector panel.

Sky KCC-S6 is for embedding into the table. The cover can be fold-in inside of the connector panel.

In closed status the Sky KCC-S6 has a three-sided cable output.

You have the choice between following cable connectors:

- solderable
- pluggable
- with convert cables

In function and application there are multifaceted possibilities. But the clou is the fantastic cable solution inside the table.

The Sky KCC-S6 is individual mountable.

Our sales team will also be pleased to offer personal assistance.

Or create it on your own! - With our *WinPlan2* software, which you can find on www.komtech.de/downloads.

The standard surface of cover and frame is black powdered, but design and construction leaves hardly nothing to be desired in customers request.

Choose between:

- Aluminium HQ Structure with Superb Resistance Eloxal
- Anodized black
- Liquid painted in RAL colour
- Further possibilities on request!

Technical Data

Outer dimension (frame)	180mm x 180mm
Inside dimension (Size of the connector plate)	136mm x 114mm
Installation high (total high)	170mm
Operating temperature	15 - 45°C



AF-TA Sky KCC-S6 cover and frame with standard surface black powdered

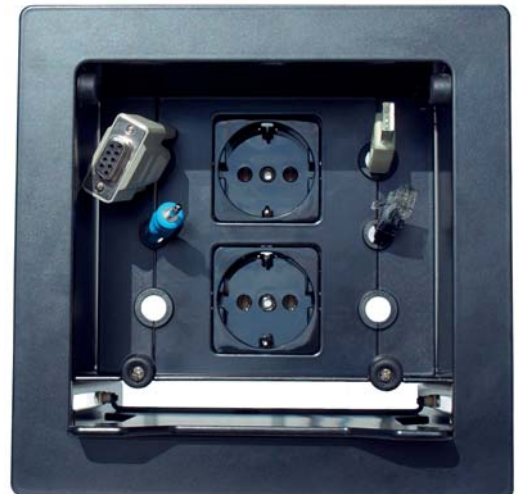

AF-TA Sky KCC-S6 with standard surface black powdered
Inside view with sample mounting and fold-in cover

Type	Item No.
AF-TA Sky KCC-S6, black powdered design	06006725
Option AF-TA frame & cover Aluminium HQ Structure	06006615
Option power socket black Type E - France (per piece)	06006730
Option power socket black Type J - CH (per piece)	06006731
Option power socket black Type G - GB (per piece)	06006732
Option power socket black Type B - USA (per piece)	06006733

Desk Connector Panel AF-TA Net Tower

The KOMTECH AF-TA Net Tower is a stand-alone connector panel. Standard configuration possesses about an one- or two-sided mounting. Optional an input from all four sides is available.

This connector panel is mobile and has a robust construction. It can be placed in every 60mm / 80mm cable feedthrough of a standard bureau desk (see picture 2). A further table is attachable smoothly.

All cables are managed inside of the connector panel leg down to the feet. Outside it is integrated in a braided hose.



Picture 2:
Net Tower in a 60mm cable feedthrough
with customized mounting

Technical Data

Dimensions (W x H x D) 25 x 83,5 x 25 cm
Power supply 230V/50Hz
Connectors standard or based on mounting
Operating temperature 5 – 45°C

Colour RAL 9005
Size of feet 50x50mm

Max. high of table 75cm

Connectors (standard)

Number of power supplies 4x Schuko
Length of connector cable 3m

Number of Catx connections 4x Cat5e
Length of connector cable 3m

Futher options

Other connector types (z. B. VGA, HDMI, Audio, LAN, etc.) and cable length on request

International power supply available on request



Picture 1:
customized solution

Type	Item No.
AF-TA Net-Tower	06006715
Option power supply black Type E - France (per piece)	06006730
Option power supply black Type J - CH (per piece)	06006731
Option power supply black Type G - GB (per piece)	06006732
Option power supply black Type B - USA (per piece)	06006733

Desk Connector Panel „Design Profil“ Series



Picture:
AF-TA DP-230 with
customized mounting
and wooden feet

The „take away“ connector panel!

The desk connector panels in design-profil are specifically developed for application in alternating environments. They are either mountable with a few easy steps by a special clamp fastening or flexible by a hook-and-loop tape from one table to an other.

Because of these mobility a multifunctional application as connector panel, e. g. in conference rooms, in hotel rooms or seminar rooms is also possible as in schools and universities or directly and simple at your desk. As a matter of course the system is also suitable for fixed installation when a fitting solution is not eligible.

Vantages:

- mobile
- flexible
- multifaceted design possibilities

Just like all other products we pay attention to a high-quality manufacturing. Another important aspect is the individual design.

The design-profiles are available by default in three different sizes, in each case in Aluminium HQ Structure with Superb Resistance Eloxal or black.

Front plate and side frames are adjustable on your individual wishes. That applies also too mounting and labelling.

Furthermore the design-profil is extendable with our PI/O control system.



Do you have any questions? Our sales team will be glad to help you!

Desk Connector Panel DP-125

with one Schuko power socket and 2,5m power cable

Technical Data:

Dimensions:

- W x H x D: 135mm x 115mm x 76

Power supply:

- 230V/50Hz

Standard connectors:

- 1x Schuko power socket
- 1x VGA female
- 1x 3,5mm jack plug female 3pin (stereo)
- 1x RJ45 female/LAN

All connectors conducted with 2,5m connector cable and male connector.



Desk Connector Panel DP-230

with two Schuko power sockets and 2,5m power cable

Technical Data:

Dimensions:

- W x H x D: 240mm x 115mm x 76mm

Power supply:

- 230V/50Hz

Standard connectors:

- 2x Schuko power socket
- 2x VGA-female
- 2x 3,5mm jack plug female 3pin (stereo)
- 2x RJ45-female / LAN

All connectors conducted with 2,5m connector cable and male connector.



Desk Connector Panel DP-380

with four Schuko power sockets and 2,5m power cable

Technical Data:

Dimensions:

- W x H x D: 390mm x 115mm x 76mm

Power supply:

- 230V/50Hz

Standard connectors:

- 4x Schuko power socket
- 2x VGA-female
- 2x 3,5mm jack plug female 3pin (stereo)
- 4x RJ45-female / LAN
- 1x USB-A female

All connectors conducted with 2,5m connector cable and male connector.



Technical Data AF-TA clamp fastening:

- Short: Dimensions 50mm (W x H x D): 20mm x 60mm x 60mm
- Long: Dimensions 80mm (W x H x D): 20mm x 90mm x 60mm

Type	Item No.
AF-TA DP-125	06006701
AF-TA DP-125 black	06006702
AF-TA DP-230	06006703
AF-TA DP-230 black	06006704
AF-TA DP-380	06006705
AF-TA DP-380 black	06006706
AF-TA clamp fastening short	06006707
AF-TA clamp fastening long	06006708
Option power supply black Type E - France (per piece)	06006730
Option power supply black Type J - CH (per piece)	06006731
Option power supply black Type G - GB (per piece)	06006732
Option power supply black Type B - USA (per piece)	06006733

Desk Connector Panel Dubai

Desk connector panel with power cable

Rounded down design and reliable technology.

► The motor-driven desk top panel AF-TA Dubai by KOMTECH.

Imagine – You're coming in a room and all what you have to do to connect your notebook is to push an invisibly button. After that the connector panel moves out of the table by oneself.

The individual mounting including a power socket is arranged on a semi-circle in the desk connector panel.

After a successful presentation the connector panel retract by oneself back in rest position. Just push the button!

External control about potential-free contacts, RS232 or RS485 to connect media control systems, is integrateable.

Don't only imagine anymore! See for yourself! The functionality and manufacturing quality of KOMTECH AF-TA Dubai.



Technical data

Dimensions (W x H (withdrawn position) x D) 110 mm x 198 mm x 218 mm
 Operating temperature 15 – 45°C

Dimensions

Dimensions visible surface
 Frames (W x D) 110 mm x 218 mm
 Dimensions mounting cut out
 Cut out (W x D) 90 mm x 198 mm
 High in withdrawn position 119 mm

Milled slot

Deepness for milled slot 3 mm

Connectors

Power supply

External power supply Data Power supply

Connectors

Power 1x 230V Schuko power socket
 LAN 1x RJ45 CAT5e female on 30 cm cable
 Image 1x VGA female on 30cm cable (15 pin Sub-HD)
 Sound 1x 3,5mm audio stereo plug on 30cm cable

Mounting

At desk
 Number of screws 4



Type	Item No.
AF-TA Dubai	06006699
Option power socket black Type E - France (per piece)	06006730
Option power socket black Type J - CH (per piece)	06006731
Option power socket black Type G - GB (per piece)	06006732
Option power socket black Type B - USA (per piece)	06006733

Under Table Connector Panel 230V

with 2m Power Cable

Invisible installation under the table top guarantees the compact mounted under table connector panels. You can choose between customized fixed or modular mounting. The frontplate is free configurable. Mounting of external modules is possible. Cable connection is alternatively solderable, pluggable or with convert cable. 24TE is standard. Different surface designs and 2x 230V power sockets are available. Optionally the signals could be conduct to the backside of the units.



Front

AF-UTA 230V 24TE

- Dimensions (W x H x D): 269mm x 61mm x 155mm

More under table connector panels are optionally available:

AF-UTA 230V 12TE Hybrid

- Dimensions (W x H x D): 269mm x 61mm x 155mm

This AF-UTA is optional available as standard or with different mounting. Against the two power sockets the 12TE Hybrid has a Cat5e feedthrough, a VGA female feedthrough, a 3,5mm jack plug feedthrough, a USB-A female feedthrough and additionally 12 TE room for modular mounting (not included in basic price).

AF-UTA 36TE

- Dimension (W x H x D): 227mm x 40mm x 152mm

Room for 36TE on front- and backside offers this UTA in each case. Intended for use without mains supply. Power sockets can't be integrated.

Technical Data UTA 230V

Power supply 230V/50Hz
Connectors depending on mounting
ambient temperature 5-45°C

features

Standard

Number of power sockets 2
Room 24TE

Max. Configurability

Max. number of power sockets 4
Max. number of modules 40TE
by non-/partially modular mounting more connectors possible

Type	Item No.
AF-UTA 230V 24TE	06006689
AF-UTA 230V 12TE Hybrid (basic price)	06006692
AF-UTA 36TE	06006525

Connector Panel desk box

with two screwing clamps and 3m power cable inclusive

The desk box, which is also suitable for wall mounting, is available in three standard sizes. with customized gravure and mounting. Special sizes are optional deliverable.

The desk box could be customized engraved and mounted with modules and cables from our range.

To prevent cable salad all cables are combined in one braided hose.

It doesn't matter in which country do you want to assemble the desk box. There is a wide stock of power sockets of different countries available!

Furthermore the desk box could be optional mounted with our PI/O control system.



Desk box 24TE with two power sockets and customized mounting

Following standard sizes are available:

- **Desk box 20TE**

Dimensions (WxHxD) 171mm x 85mm x 145mm with one power socket

- **Desk box 24TE**

Dimensions (WxHxD) 246mm x 85mm x 145mm with two power sockets

- **Desk box 40TE**

Dimensions (WxHxD) 327mm x 85mm x 145mm with two power sockets



Desk box 20TE with one power socket without mounting

Type	Item No.
AF desk box 20TE	06006537
AF desk box 24TE	06006566
AF desk box 40TE	06006565
M&B fee 20TE	06006563
M&B fee 24TE	06006552
M&B fee 40TE	06006557
AF-TA customized gravure	06006645

Desk connector panel AF-TA Conference

with integrated **Revoluto** microphone powered by **beyerdynamic))))**

The KOMTECH AF-TA Conference is an ideal combination for video conference technology and/or round table discussions. Communication terminal and PC connector technology realized in one solution.

AF-TA Conference based on the KOMTECH desk connector panel Hybrid T-380 in an elegant, high-quality design, in which we built-in a fold-out **Revoluto** microphone.

Original patented **beyerdynamic))))** technology guaranteed excellent speech intelligibility by optimized corridor characteristic.

In the AF-TA Conference are integrated 2x Schuko power sockets and connectors for 2x LAN, 2x VGA, 2x 3,5mm stereo jack (Feed Through). A customized adaption like modular mounting, different connectors or surface design e. g., is possible.



Image: customized mounting

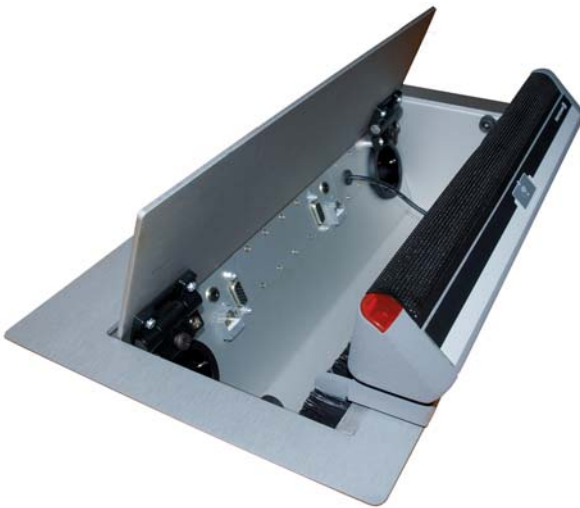

In design and type the colouring is composed according to your wishes. Frame and cover are available in the following versions:

- Aluminium HQ Structure
- Aluminium rolled
- Stainless steel
- Corian®
- TIN surface
- Veneered
- **Choose from over 500 different surface decors**

Optional the AF-TA Hybrid is available with circular chamfered or rounded outside edges.

Technical Data connector panel

look at „AF-TA Hybrid T-380“ (Item No. 06006757)

Technical Data Revoluto

Converter principle	Condenser (Back-Elektret)
Frequency range	130 - 17000Hz
Directional characteristic	Passage
Ideal speaker distance	60 - 80cm
Field neutral gear transfer factor	ca. 200mV/PA
Rated impedance	200Ω
Noise power distance	60dB (based on 1PA)
Distortion factor	<0,1%
Power supply	Phantom Feeding 48V (44 - 52V) / 8mA
Connector	3pin XLR

Type	Item No.
AF-TA Conference	on request
AF-TA Hybrid T-380 Basis HQ Structure (incl. cover & frame)	06006757
AF-TA Option MPR Revoluto mounting (suitable for Item No. 06006757)	06006755

Desk connector panel USB Hub

with 1,5m USB and 2x audio cable

You are searching for a small and invisible possibility to connect USB units directly at your desk?
- Here is our USB Hub 3Port Desk 60 with 2x3,5mm.

The surface of the USB Hub is Aluminium HQ Structure with Superb Resistance Eloxal.
It has a diameter of 90mm (mounting Ø 60mm), three USB-A Ports and two 3,5mm mini jacks to connect a headset.

A data transfer of up to 480Mbps is possible.
The USB Hub is supported by Windows and MacOS.



USB Hub, side view
with cable

Technical Data

USB 2.0 Hub

To mount inside the desk cable feedthrough

- USB-A plug > 3x USB-A jack
- with 2x 3,5mm audio jack to connect a headset
- up to 480 Mbps data transfer
- incl. 1,5m USB cable and audio cable (2x 3,5mm)
- supported by Windows and MacOS

Mounting Ø 60mm

KOMTECH Motorized Cable Retractor

The KOMTECH motorized cable retractor managed the connector cables where they are needed.
 With the help of an unique cable guide the cable can be pulled out easily up to 70cm. Because of its electromechanical design the cable will be removed automatically with constant power after use by touching an button with constant power. Same quality for more than 1000 uses.

When the cable is moved back to its basic position a watchdog unit looks if there is anything that handicaps the cable.

The cable retractor is an perfect complement for KOMTECH connector panels.
 Installation options: horizontal or vertical.

Cables for following signals be supported:

- VGA
- Audio
- HDMI
- CATx
- Display Port
- USB 2.0
- DVI

The foundation is an universal cassette without cables.
 Cable configuration is optional of customers request.

INFORMATION:

Every cable requires its own cable cassette!



Picture:
Connectors

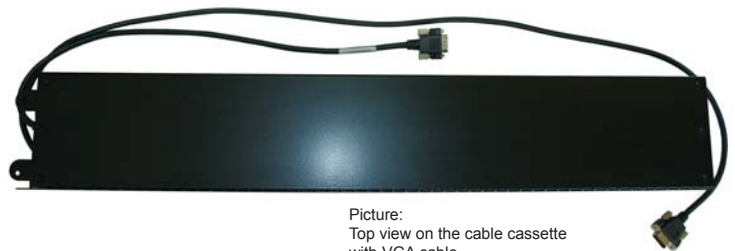

Picture:
Top view on the cable cassette
with VGA cable

Technical data

Dimensions cable cassette (LxHxB) 660mm x 125mm x 42mm
 Weight 4kg
 Power connection 110V - 240V AC / 50-60Hz

Picture:
Mounting bracket for
vertical mounting



Picture:
Mounting bracket for
horizontal mounting

Accessories

- Connector for button or external control
- Mounting brackets
- External power supply



Example:
 Desk connector panel T-300 with customized cable configuration, push buttons in stainless steel optics and two Schuko power socketw.
 The motorized cable retractor disappears invisibly behind the connector panel and under the table.

You have questions?

Or other different, individual ideas?

► **Our sales team will be pleased to help you!**

Type	Item No.
AF-Z motorized cable retractor	06004000
Power supply A for motorized cable retractor (for up to 2 cassettes)	06004001
Power supply B for motorized cable retractor (for up to 4 cassettes)	06004002

Connector panels for light switch frames

KOMTECH offers module carriers for all common light switch frames. That way you can integrate up to 8TE on one carrier. The manufacturing of aluminium makes it a long-living product with a high quality surface. Custom requests may be consider anytime.

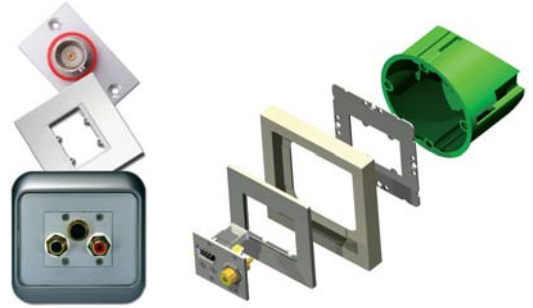

The range of light switch frames of all manufactures is growing constantly. To be able to combine as many connectors in one switch frame as possible we offer spezial fixed mounted forms for some programs. These are mounted non-modular, but they offers the option to mount up to 6 different female connectors on a small space.

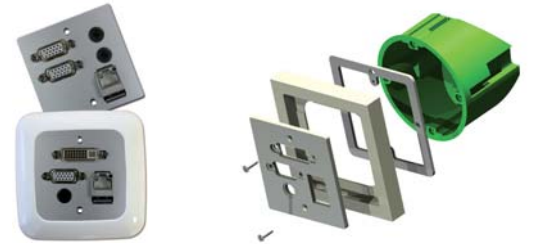

Modular mounting - multifaceted options



Examples - modules not includes in delivery

Standard configurations for light switch frames



Depending on connector type the module may be delivered backside in following versions:

- solderable
- pluggable
- with a connector cable and a corresponding mating connector

**Other modules or customized solutions available on request.
Contact us for your individual solution.**

Typ	Art.-Nr.
AF-S UP-Berker Arsys	06006620
AF-S UP Berker B3	06006680
AF-S UP Berker B7	06006681
AF-S UP-Berker K1	06006586
AF-S UP-Berker Modul 2 weiß	06006676
AF-S UP-Berker S1	06006587
AF-S UP-Berker Twinpoint	06006682
AF-S UP-Busch-Jäger Alpha Nea	06006582
AF-S UP-Busch-Jäger SI	06006581
AF-S UP-Busch-Jäger Linear	06006579
AF-S UP-Busch-Jäger Future Linear	06006621
AF-S UP-Gira Esprit	06006593
AF-S UP-Gira Event	06006618
AF-S UP-Gira S-Color	06006622
AF-S UP-Gira Standard 55	06006583
AF-S UP-Jung AS 500	06006683
AF-S UP-Jung CD 500	06006584
AF-S UP-Jung Edelstahl	06006689
AF-S UP-Jung LS 990	06006585
AF-S UP-Jung LS Plus	06006684
AF-S UP-Legrand Struktura Kristall	06006594
AF-S UP-Legrand CREO	06006688
AF-S UP-Merten Atelier	06006573
AF-S UP-Merten M ARC	06006577
AF-S UP-Merten M Echtglas	06006574
AF-S UP-Merten M Plan	06006578
AF-S UP-Merten M 1	06006576
AF-S UP-Merten Panzer	06006685
AF-S UP-Siemens Delta Line	06006599
AF-S UP-Siemens Delta Miro Glas	06006597
AF-S UP-Siemens Delta Vita	06006598
AF-S UP-Schalterdose 2x8TE	06006539
AF-S UP-Schalterdose 8TE	06006528

 **You can not find YOUR switch frame program?
Contact our sales associates !**

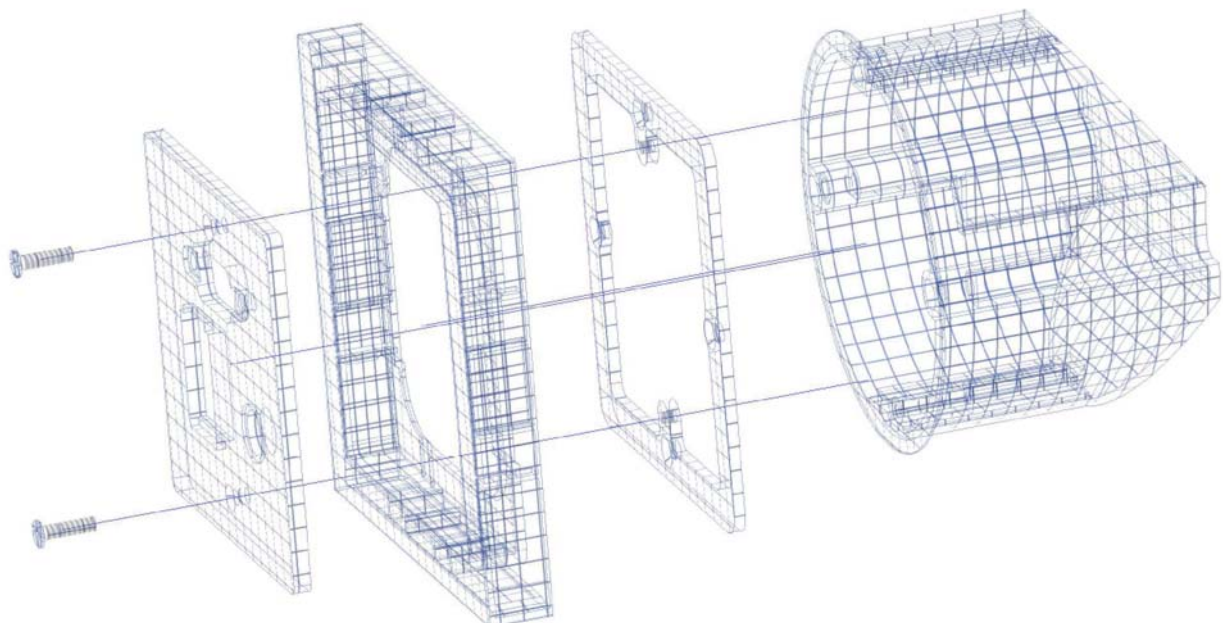

Connector panels for floor pods - „FLEX“ - the ex-tank solution

The floor pod is an essential element in every bureau or conference room.

The „FLEX“ floor pods without tank offer a lot of space for different modules, which can choose free from the KOMTECH module program. They have the advantage to have a lot of room even for long feedthroughs. Cables can be mounted directly on a mounting plate in a „FLEX“ floor pod.

The floor pod tanks are sourced exclusively from well-known producer like Ackermann, OBO-Bettermann, Electraplan, Kleinhuis and VanGeel. PUK tanks are available on request.

- ▶ Prepare yourself your own individual floor pod!
With **WinPlan 2**, which you can find on our homepage!



Type	Item No.
AF-BT FLEX Ackermann GES9B/GB3 36TE	06006625
AF-TA mounting & labeling flat charge 36TE	06006550



Picture:
customized
mounting

Type	Item No.
AF-BT Ackermann GES9B/GB3 16TE	06006595
AF-TA mounting & labeling flat charge 16TE	06006564



Type	Item No.
AF-BT FLEX Electraplan GB3/GBR3 36TE	06006455
AF-TA mounting & labeling flat charge 36TE	06006550



Type	Item No.
AF-BT FLEX Electraplan GBV4 36TE	06006456
AF-TA mounting & labeling flat charge 36TE	06006550



Type	Item No.
AF-BT Electraplan GB2-Becher	06006513
AF-TA mounting & labeling flat charge 28TE	06006551



Type	Item No.
AF-BT Kleinhuis Becher 3x12TE	06006516
AF-TA mounting & labeling flat charge 36TE	06006550

VGA interface for floor pod mounting

- Bandwidth 500MHz
- Integrated power supply
- With activ audio balancing unit
- RGB amplification, Sync converter, H-Shift and audio level outside adjustable
- Floor pod cover also closeable by fixed connector cables
- Delivery inclusive 1x connector cable 15pin HD male/male 2m and adapter cable 15pin HD male on 5xBNC coupling



Technical Data

Dimensions (B x H x T)	73mm x 55mm x 80mm
Power supply	230V/50Hz; Fuse 50mA
Connectors	15pol HD female; 3,5mm stereo plug female, Phoenix female
Ambient temperature	5 - 45°C

Audio

Volume

Level	-6dB/+10dB
	max. Level (v=1)/THD<0,2%/1KHz
Last 100kR	+16dBu
Last 600R	+15dBu
Nominal	+6dBu
THD+N	0,02%/1KHz/600R
THD+N	0,02%/10KHz/600R

Noise

UWTD (22-22KHz)	≤94bBq
WTD	≤88bBq

Crosstalk

100Hz	-68dB
1KHz	-68dB
10KHz	-66dB

Frequency response

35Hz - 35MHz	±0,5dB
--------------	--------

Input

Input impedance	≥33KΩ
-----------------	-------

Output

Output impedance	≤80KΩ
------------------	-------

**Minimum order quantity
- 25 units -**

Type	Item No.
AF-BT VGA-Interface floor pod	06000890

Equipment for floor pods



Connector panel extension 12TE for VGA-Interface mounting frame (Art.-Nr. 06000871)

- makes mounting of additional connector panel moduls with max.12TE width possible
- (unsuitable for GESB/GB2)

Type	Item No.
AF-BT extension 12TE Interface	06000877

Equipment for floor pods



Mounting frame for VGA-Interface, suitable instead of a cup

- Ackermann GES9B/GB3
- Electraplan GB3

Type	Item No.
AF-BT mounting frame instead of GES9B/GB3	06000871



Mounting frame for VGA-Interface, suitable instead of a cup

- Ackermann GESB/GB2

Type	Item No.
AF-BT mounting frame instead of GESB/GB2	06000872

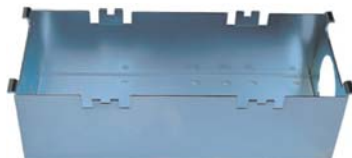

Mounting frame for VGA-Interface, suitable instead of a cup

- Ackermann GES9B/GB3
- Electraplan GB3

Type	Item No.
AF-BT mounting frame instead of Kleinhuis	06000876

Connector panels for cable channels

Cable channel connector panel

Other lengths and configurations deliverable.
(e.g. with power sockets)

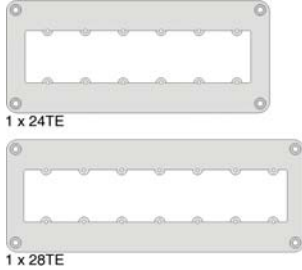

Type	Item No.
AF-W 24TE wall channel	06006509
Mounting & Labeling flat charge 24TE	06006552
AF-W 28TE wall channel	06006524
Mounting & Labeling flat charge 28TE	06006551
AF-W 32TE wall channel	06006545
Mounting & Labeling flat charge 32TE	06006562
AF-W 36TE wall channel	06006533
Mounting & Labeling flat charge 36TE	06006550
AF-W 48TE wall channel	06006507
Mounting & Labeling flat charge 48TE	06006558
AF-19" 1HE 84TE	06006506
Mounting & Labeling flat charge 84TE	06006555
AF-W 2x24TE wall channel	06006503
Mounting & Labeling flat charge 2x24TE	06006553
AF-W 2x32TE wall channel	06006538
Mounting & Labeling flat charge 2x32TE	06006556
AF-W 2x48TE wall channel	06006504
Mounting & Labeling flat charge 2x48TE	06006554

Slanted wall connector panel

Connector panel people like to obstruct in the wall channel.
Because of the slant the plugs don't apply. In addition, the slant offers a breaking off protection and you can't get caught on it.



Type	Item No.
AF-W 8TE wall channel slanted	06006540
Mounting & Labeling flat charge 8TE	06006559
AF-W 20TE wall channel slanted	06006541
Mounting & Labeling flat charge 20TE	06006563
AF-W 28TE wall channel slanted	06006542
Mounting & Labeling flat charge 28TE	06006551

Connector panel for in-wall socket

The classic connecting way for in-wall sockets.

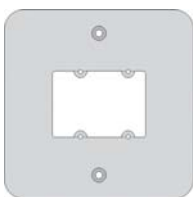

Type	Item No.
AF-S in-wall socket 8TE	06006528
Mounting & Labeling flat charge 8TE	06006559
AF-S in-wall socket 2x8TE	06006539
Mounting & Labeling flat charge 16TE	06006564

Connector panel for external wall boxes

Delivery inclusive external wall frames

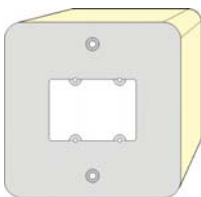

Typ	Art.-Nr.
AF-W external wall box 8TE	06006547
M&B Pauschale 8TE	06006559
AF-W external wall box 2x8TE	06006539
M&B Pauschale 16TE	06006564
AF-W external wall box 2x32TE	06006511
AF-W in-wall box 2x32TE	06006546
M&B Pauschale 2x32TE	06006556

Connector panel for surface mounting housing with integrated VGA interface

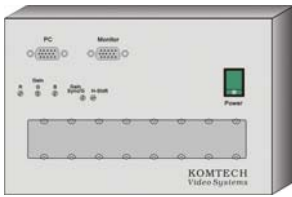

Type	Item No.
AF-W surface mounting housing 32TE VGA interface	06006534
Mounting & Labeling flat charge 32TE	06006562

Wall connector panels with integrated VGA interface

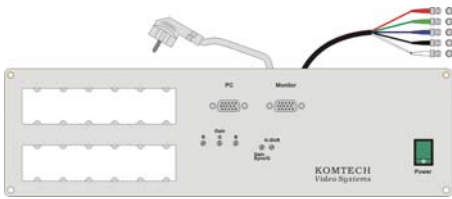

Wall connector panel with VGA interface 2x24TE

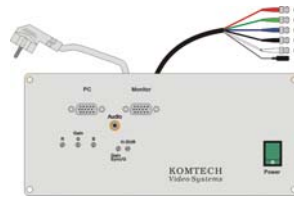

VGA interface for cable duct



Wall connector panel with VGA interface 2x24TE

Type	Item No.
AF-W 2x24TE wall channel VGA interface	06006505
AF-W 2x24TE wall channel VGA/audio interface	06006549
Mounting & Labeling flat charge 2x24TE	06006553
AF-19" 3HE 2x40TE interface	06006527
Mounting & Labeling flat charge 2x40TE	06006561
AF-W VGA interface passiv audio cable channel	06006536
AF-W VGA interface activ audio cable channel	06006580

Technical Data

Dimensions (W x H x D)
Power supply

350mm x 100mm x 43mm
230V/50Hz; Fuse 50mA
(Fixed connector cable 1,8m with safety plug)
BNC female cable connector/15pin HD Sub-D-female

Connectors
Operating temperature

5 - 45°C

Input

Input impedance
Input coupling
Maximum voltage (v=1)
Sync-input impedance
Sync-input level
Audio-input

75Ω
DC
±1,5V
560Ω (switchable between 75Ω and 560Ω)
TTL
3,5mm stereo mini jack; passiv

Output

Number of
Output impedance
Sync-outputs BNC

2 (1x 15pin HD Sub-D females; 1 x BNC-RGBHV)
75Ω
H-Sync and V-Sync separately
(H-Sync and V-Sync as C-Sync on H-Sync Out; Sync on green)

Frequency response

up to 300MHz

-3dB

Universal characteristics

amplification adjustable

-1,5/+3dB

Mounting & Labeling flat charge:

We'll **mount** the modules in the connector panels customized and we'll **label** them.

KOMTECH Kommunikationstechnik GmbH
Straßheimer Str. 45
61169 Friedberg / Hessen
Deutschland
Fon 0049 (0) 60 31 / 79 47 - 0
Fax 0049 (0) 60 31 / 79 47 - 47
Mail info@komtech.de
Web www.komtech.de
